

# IRF7476PbF

HEXFET® Power MOSFET

## Applications

- High Frequency 3.3V and 5V input Point-of-Load Synchronous Buck Converters for Netcom and Computing Applications.
- Power Management for Netcom, Computing and Portable Applications.
- Lead-Free

## Benefits

- Ultra-Low Gate Impedance
- Very Low  $R_{DS(on)}$
- Fully Characterized Avalanche Voltage and Current

$V_{DSS}$	$R_{DS(on)} \text{ max}$	$I_D$
12V	8.0mΩ@ $V_{GS} = 4.5V$	15A

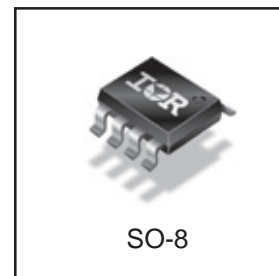
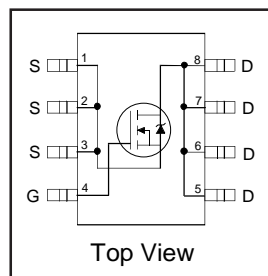

## Absolute Maximum Ratings

Symbol	Parameter	Max.	Units
$V_{DS}$	Drain-Source Voltage	12	V
$V_{GS}$	Gate-to-Source Voltage	±12	V
$I_D @ T_A = 25^\circ C$	Continuous Drain Current, $V_{GS} @ 10V$	15	A
$I_D @ T_A = 70^\circ C$	Continuous Drain Current, $V_{GS} @ 10V$	12	
$I_{DM}$	Pulsed Drain Current <sup>①</sup>	120	
$P_D @ T_A = 25^\circ C$	Maximum Power Dissipation <sup>④</sup>	2.5	W
$P_D @ T_A = 70^\circ C$	Maximum Power Dissipation <sup>④</sup>	1.6	W
	Linear Derating Factor	0.02	W/°C
$T_J, T_{STG}$	Junction and Storage Temperature Range	-55 to + 150	°C

## Thermal Resistance

Symbol	Parameter	Typ.	Max.	Units
$R_{\theta JL}$	Junction-to-Drain Lead	—	20	°C/W
$R_{\theta JA}$	Junction-to-Ambient <sup>④</sup>	—	50	

Notes <sup>①</sup> through <sup>④</sup> are on page 8  
[www.irf.com](http://www.irf.com)

# IRF7476PbF

International  
**IR** Rectifier

## Static @ $T_J = 25^\circ\text{C}$ (unless otherwise specified)

	Parameter	Min.	Typ.	Max.	Units	Conditions
$V_{(BR)DSS}$	Drain-to-Source Breakdown Voltage	12	—	—	V	$V_{GS} = 0V, I_D = 250\mu A$
$\Delta V_{(BR)DSS}/\Delta T_J$	Breakdown Voltage Temp. Coefficient	—	0.014	—	V/ $^\circ\text{C}$	Reference to $25^\circ\text{C}, I_D = 1\text{mA}$
$R_{DS(on)}$	Static Drain-to-Source On-Resistance	—	6.0	8.0	m $\Omega$	$V_{GS} = 4.5V, I_D = 15A$ ③
		—	12	30		$V_{GS} = 2.8V, I_D = 12A$ ③
$V_{GS(th)}$	Gate Threshold Voltage	0.6	—	1.9	V	$V_{DS} = V_{GS}, I_D = 250\mu A$
$I_{DSS}$	Drain-to-Source Leakage Current	—	—	100	$\mu A$	$V_{DS} = 9.6V, V_{GS} = 0V$
		—	—	250		$V_{DS} = 9.6V, V_{GS} = 0V, T_J = 125^\circ\text{C}$
$I_{GSS}$	Gate-to-Source Forward Leakage	—	—	200	nA	$V_{GS} = 12V$
	Gate-to-Source Reverse Leakage	—	—	-200		$V_{GS} = -12V$

## Dynamic @ $T_J = 25^\circ\text{C}$ (unless otherwise specified)

Symbol	Parameter	Min.	Typ.	Max.	Units	Conditions
$g_{fs}$	Forward Transconductance	31	—	—	S	$V_{DS} = 6.0V, I_D = 12A$
$Q_g$	Total Gate Charge	—	26	40	nC	$I_D = 12A$
$Q_{gs}$	Gate-to-Source Charge	—	4.6	—		$V_{DS} = 10V$
$Q_{gd}$	Gate-to-Drain ("Miller") Charge	—	11	—		$V_{GS} = 4.5V$
$Q_{oss}$	Output Gate Charge	—	17	—		$V_{GS} = 0V, V_{DS} = 5.0V$
$t_{d(on)}$	Turn-On Delay Time	—	11	—	ns	$V_{DD} = 6.0V$
$t_r$	Rise Time	—	29	—		$I_D = 12A$
$t_{d(off)}$	Turn-Off Delay Time	—	19	—		$R_G = 1.8\Omega$
$t_f$	Fall Time	—	8.3	—		$V_{GS} = 4.5V$ ③
$C_{iss}$	Input Capacitance	—	2550	—	pF	$V_{GS} = 0V$
$C_{oss}$	Output Capacitance	—	2190	—		$V_{DS} = 6.0V$
$C_{riss}$	Reverse Transfer Capacitance	—	450	—		$f = 1.0\text{MHz}$

## Avalanche Characteristics

Symbol	Parameter	Typ.	Max.	Units
$E_{AS}$	Single Pulse Avalanche Energy②	—	160	mJ
$I_{AR}$	Avalanche Current①	—	12	A

## Diode Characteristics

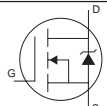
Symbol	Parameter	Min.	Typ.	Max.	Units	Conditions
$I_S$	Continuous Source Current (Body Diode)	—	—	2.5	A	MOSFET symbol showing the integral reverse p-n junction diode. 
$I_{SM}$	Pulsed Source Current (Body Diode) ①	—	—	120		
$V_{SD}$	Diode Forward Voltage	—	0.87	1.2	V	$T_J = 25^\circ\text{C}, I_S = 12A, V_{GS} = 0V$ ③
		—	0.73	—		$T_J = 125^\circ\text{C}, I_S = 12A, V_{GS} = 0V$ ③
$t_{rr}$	Reverse Recovery Time	—	55	82	ns	$T_J = 25^\circ\text{C}, I_F = 12A, V_R = 12V$
$Q_{rr}$	Reverse Recovery Charge	—	59	89	nC	$di/dt = 100A/\mu s$ ③
$t_{rr}$	Reverse Recovery Time	—	54	81	ns	$T_J = 125^\circ\text{C}, I_F = 12A, V_R = 12V$
$Q_{rr}$	Reverse Recovery Charge	—	60	90	nC	$di/dt = 100A/\mu s$ ③

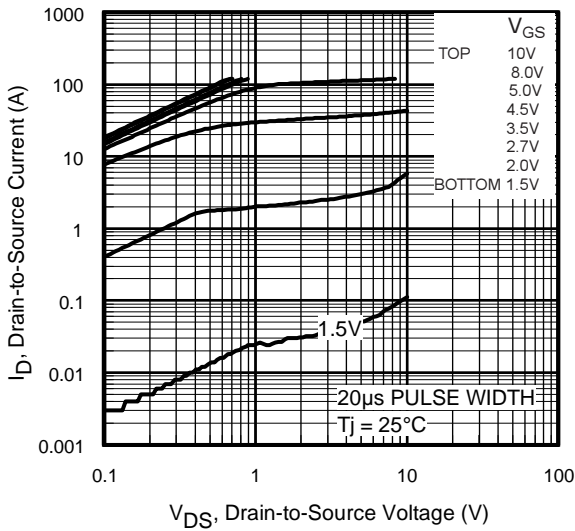

Fig 1. Typical Output Characteristics

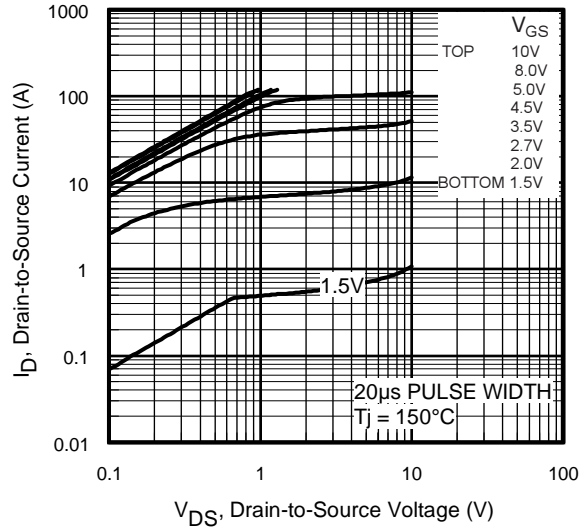

Fig 2. Typical Output Characteristics

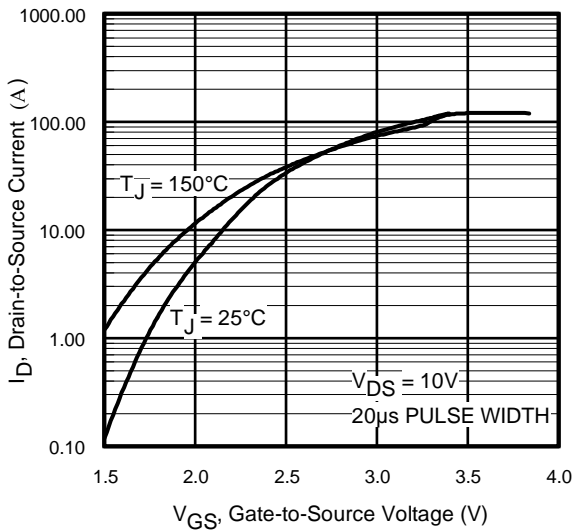

Fig 3. Typical Transfer Characteristics

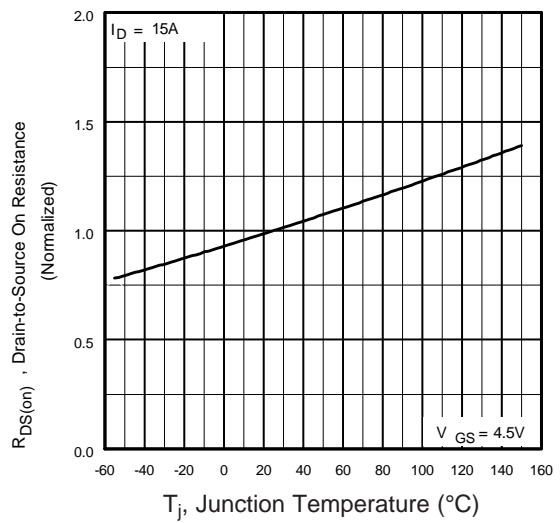
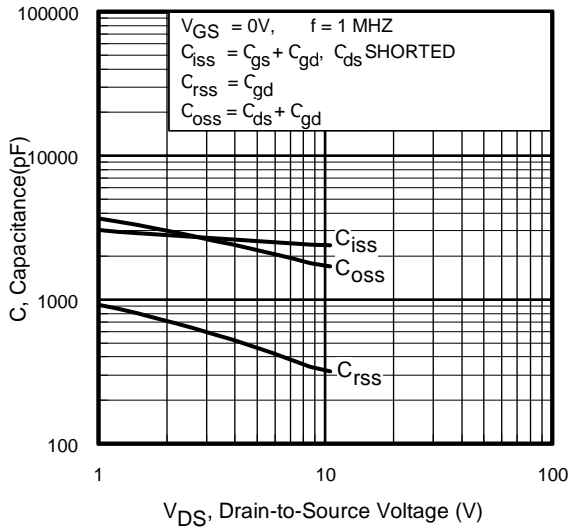
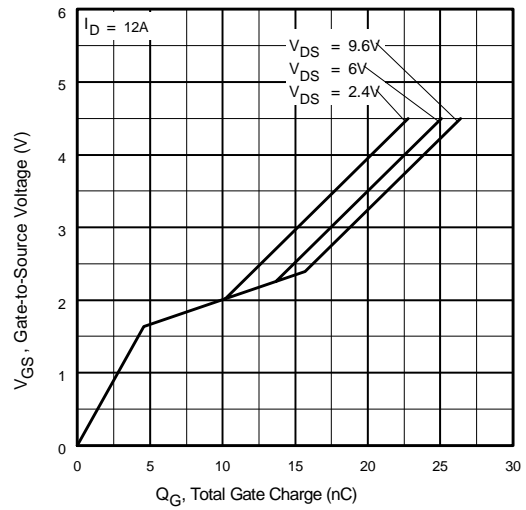

Fig 4. Normalized On-Resistance Vs. Temperature

# IRF7476PbF



**Fig 5.** Typical Capacitance Vs. Drain-to-Source Voltage



**Fig 6.** Typical Gate Charge Vs. Gate-to-Source Voltage

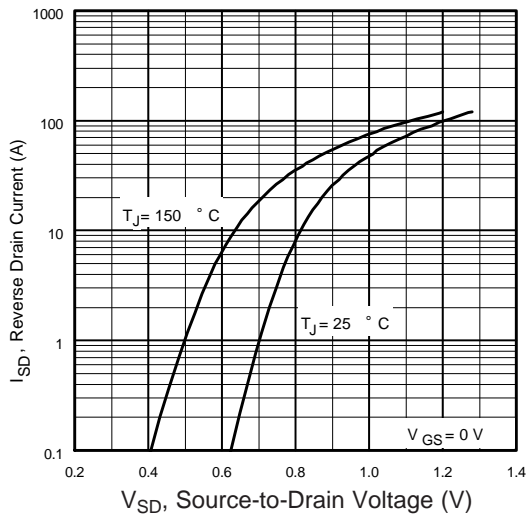

**Fig 7.** Typical Source-Drain Diode Forward Voltage

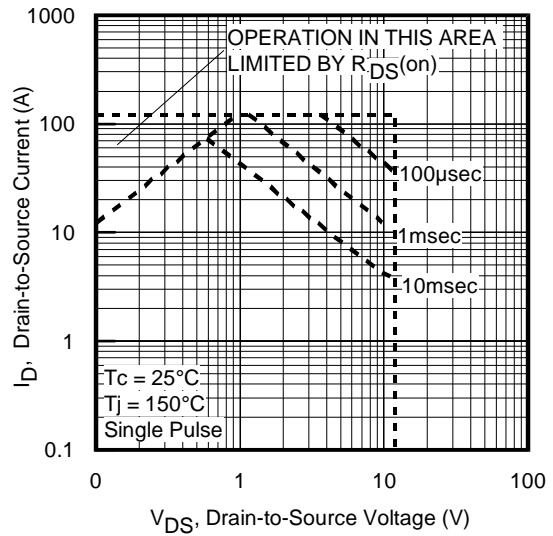

**Fig 8.** Maximum Safe Operating Area

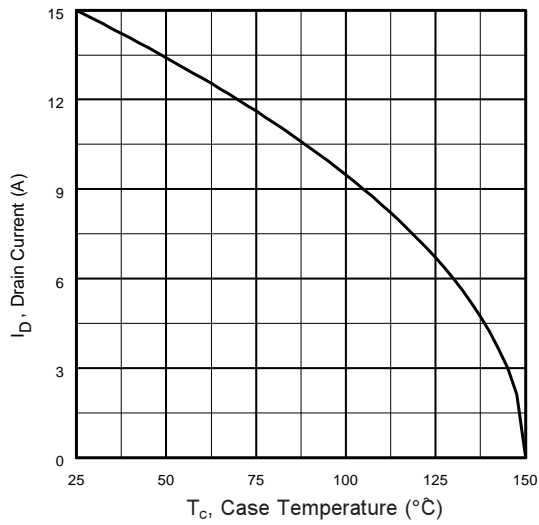

**Fig 9.** Maximum Drain Current Vs. Case Temperature

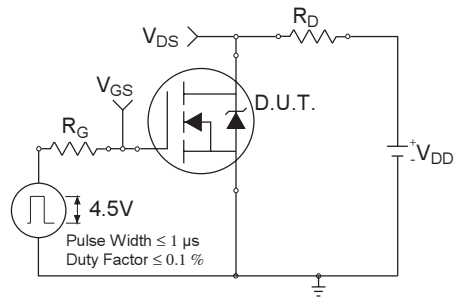

**Fig 10a.** Switching Time Test Circuit

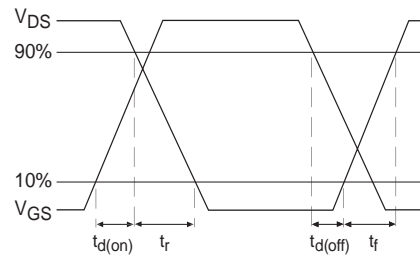

**Fig 10b.** Switching Time Waveforms

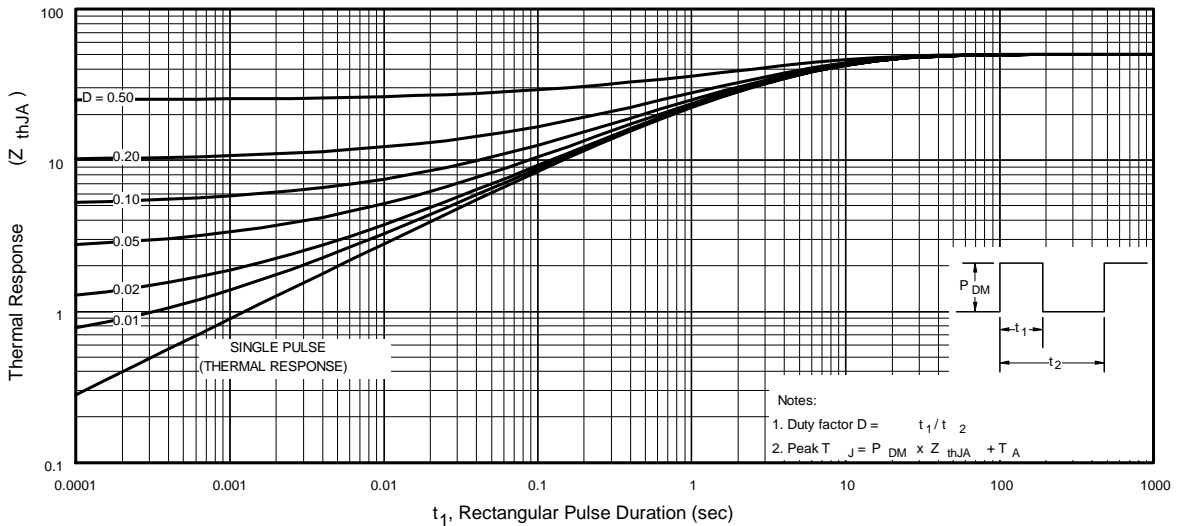

**Fig 10.** Maximum Effective Transient Thermal Impedance, Junction-to-Case

# IRF7476PbF

International  
**IR** Rectifier

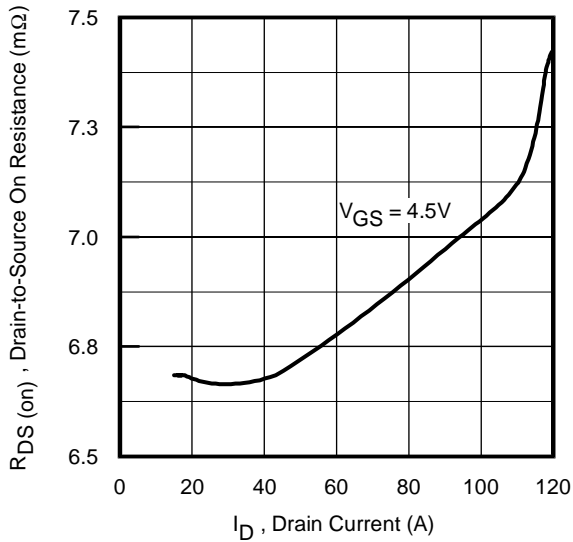

**Fig 12.** On-Resistance Vs. Drain Current

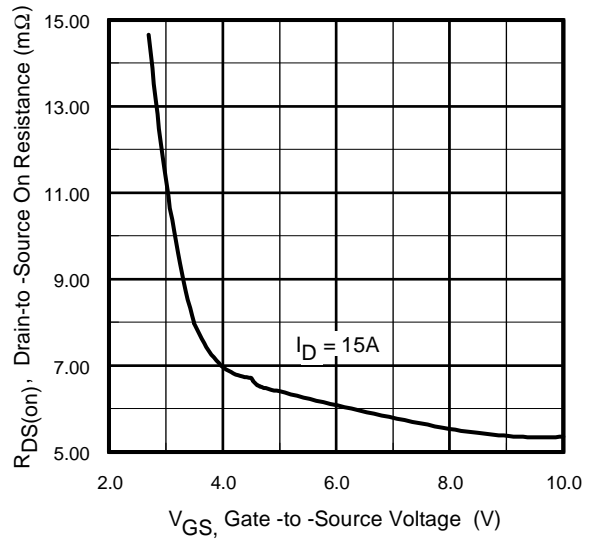

**Fig 13.** On-Resistance Vs. Gate Voltage

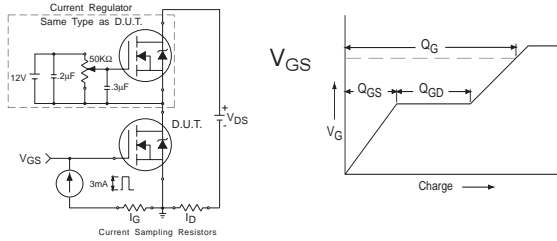

**Fig 13a&b.** Basic Gate Charge Test Circuit and Waveform

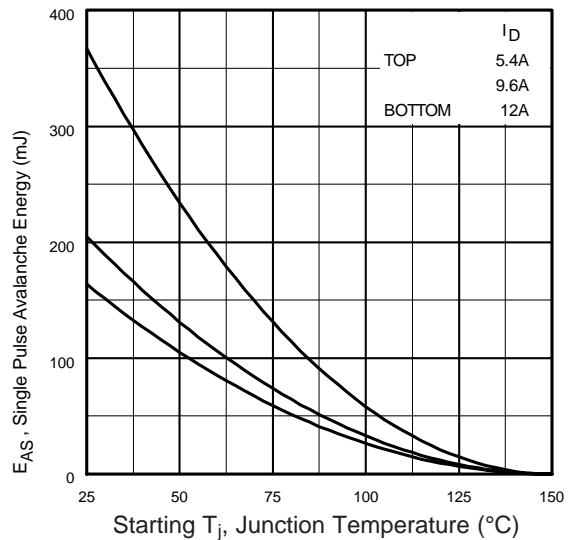

**Fig 14c.** Maximum Avalanche Energy Vs. Drain Current

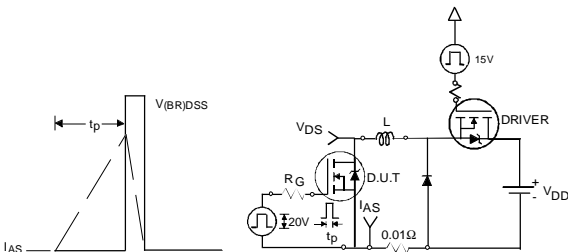

**Fig 14a&b.** Unclamped Inductive Test circuit and Waveforms

## SO-8 Package Outline

Dimensions are shown in millimeters (inches)

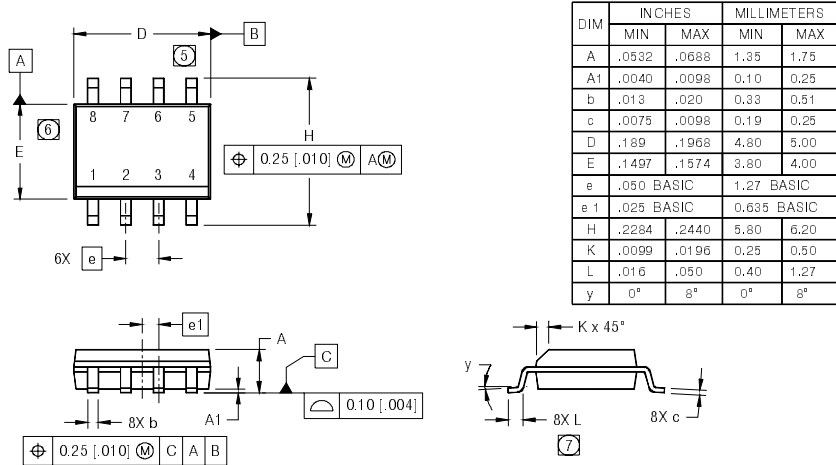

- NOTES:
1. DIMENSIONING & TOLERANCING PER ASME Y14.5M-1994.
  2. CONTROLLING DIMENSION: MILLIMETER
  3. DIMENSIONS ARE SHOWN IN MILLIMETERS [INCHES].
  4. OUTLINE CONFORMS TO JEDEC OUTLINE MS-012AA.
  5. DIMENSION DOES NOT INCLUDE MOLD PROTRUSIONS. MOLD PROTRUSIONS NOT TO EXCEED 0.15 [0.006].
  6. DIMENSION DOES NOT INCLUDE MOLD PROTRUSIONS. MOLD PROTRUSIONS NOT TO EXCEED 0.25 [0.010].
  7. DIMENSION IS THE LENGTH OF LEAD FOR SOLDERING TO A SUBSTRATE.

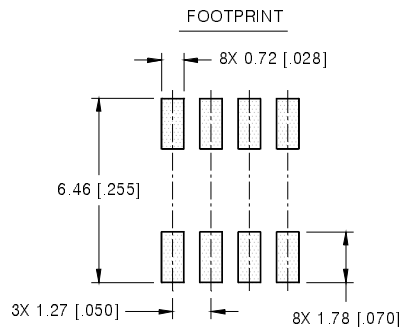

## SO-8 Part Marking Information

EXAMPLE: THIS IS AN IRF7101 (MOSFET)

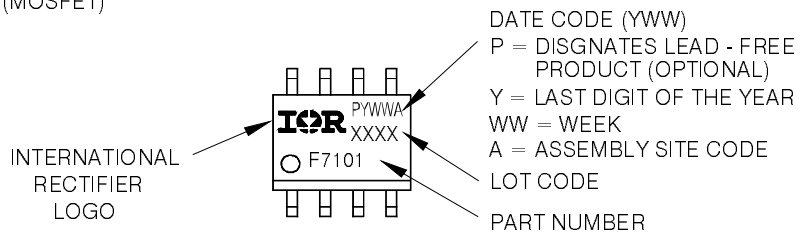

# IRF7476PbF

## SO-8 Tape and Reel

International  
**IR** Rectifier

Dimensions are shown in millimeters (inches)

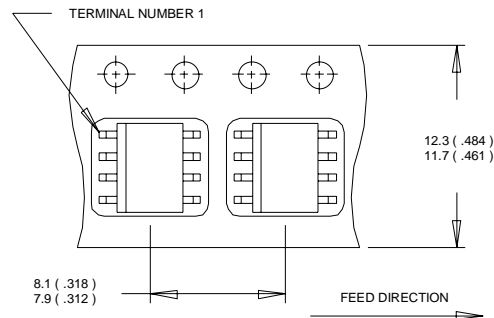

- NOTES:
1. CONTROLLING DIMENSION : MILLIMETER.
  2. ALL DIMENSIONS ARE SHOWN IN MILLIMETERS(INCHES).
  3. OUTLINE CONFORMS TO EIA-481 & EIA-541.

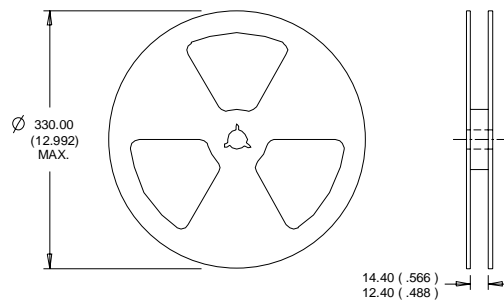

- NOTES :
1. CONTROLLING DIMENSION : MILLIMETER.
  2. OUTLINE CONFORMS TO EIA-481 & EIA-541.

### Notes:

- ① Repetitive rating; pulse width limited by max. junction temperature.
- ② Starting  $T_J = 25^\circ\text{C}$ ,  $L = 2.3\text{mH}$   
 $R_G = 25\Omega$ ,  $I_{AS} = 12\text{A}$ .
- ③ Pulse width  $\leq 400\mu\text{s}$ ; duty cycle  $\leq 2\%$ .
- ④ When mounted on 1 inch square copper board.

Data and specifications subject to change without notice.  
This product has been designed and qualified for the Consumer market.  
Qualifications Standards can be found on IR's Web site.

International  
**IR** Rectifier

IR WORLD HEADQUARTERS: 233 Kansas St., El Segundo, California 90245, USA Tel: (310) 252-7105  
TAC Fax: (310) 252-7903

Visit us at [www.irf.com](http://www.irf.com) for sales contact information.04/2006

[www.irf.com](http://www.irf.com)